

NOTES:

| REVISIONS | | | |
|-----------|---------------|------------|----------|
| REV. | DESCRIPTION | DATE | APPROVED |
| A | FULL RELEASED | 2023/11/29 | CT |

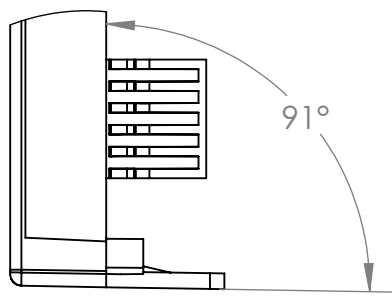

DETAIL C
SCALE 1 : 1

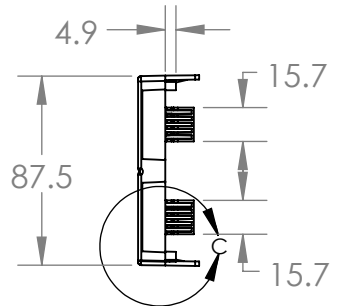
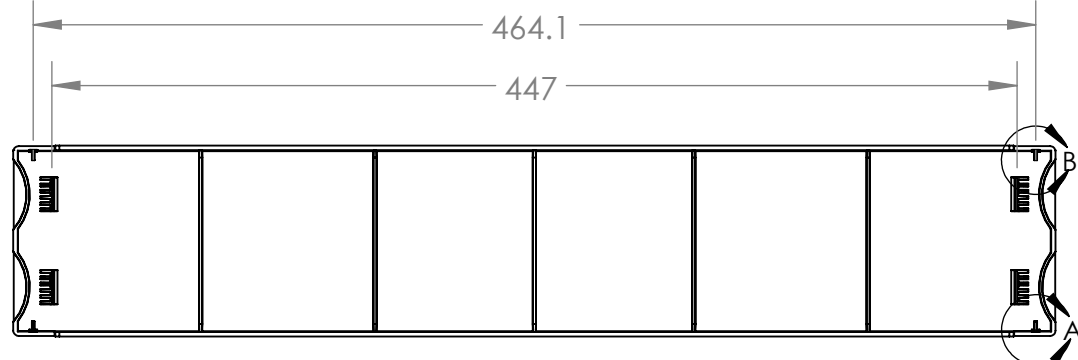
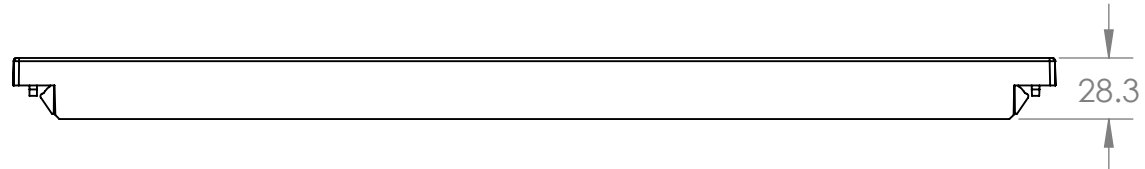
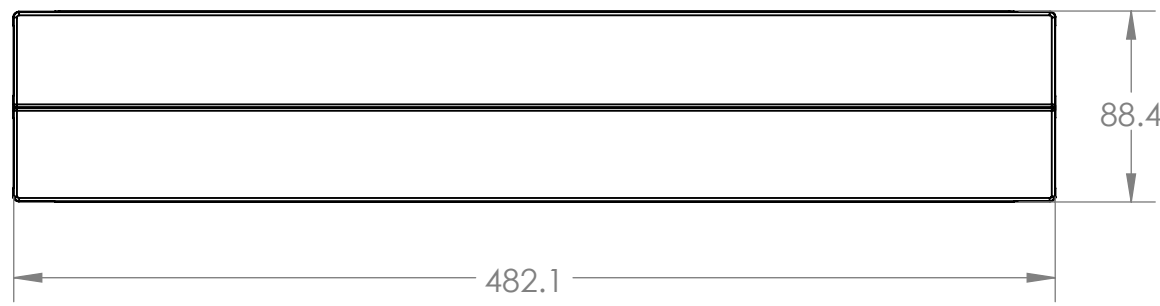
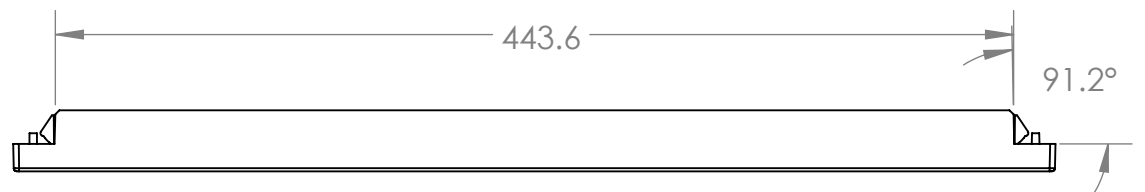
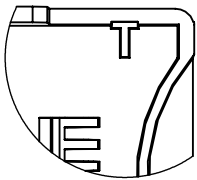

DETAIL B
SCALE 1 : 1

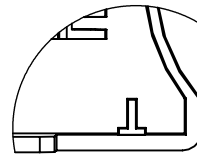

DETAIL A
SCALE 1 : 1

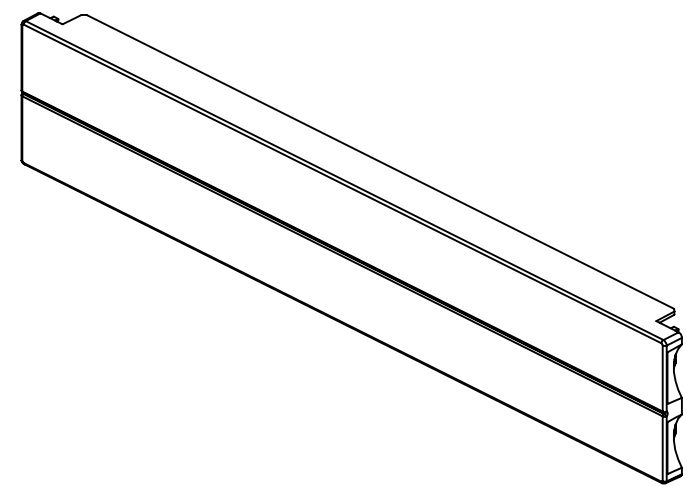

| | | | | | | | | | |
|---|--|----------------------------------|--|--------------------------|--------------------------------------|--|-----------------------|--|----------------------|
| <p>PROPRIETARY AND CONFIDENTIAL</p> <p>THIS DRAWING AND ITS SPECIFICATIONS ARE THE PROPERTY OF INOVA AND SHALL NOT BE COPIED, REPRODUCED, OR USED IN WHOLE OR IN PART, AS THE BASIS FOR THE MANUFACTURE OR SALE OF ITEMS WITHOUT THE WRITTEN PERMISSION FROM INOVA. THIS DRAWING IS BASED UPON THE LATEST AVAILABLE INFORMATION AND IS SUBJECT TO CHANGE WITHOUT NOTICE.</p> | <p>UNLESS OTHERWISE SPECIFIED</p> <p>X = ± 1 X.X = ± 0.5 X.XX = ± 0.30 X.XXX = ± 0.130</p> <p>ANGULAR X = 1° .X = 0.5° .XX = 0.25°</p> | <p>INTERPRET TO ASME Y14.100</p> | <p>DESCRIPTION: CABINET ACCESSORY, 19" 2U BLANKING PANEL, WHITE, UL94-V0</p> | | <p>DRAWING NO: INV08-00004W</p> | | <p>REV NO: A</p> | | |
| | | | <p>MATERIAL: ABS, UL94-V0</p> | | <p>FINISH: COLOR: WHITE</p> | | <p>CLASS: N/A</p> | | <p>SIZE: B</p> |
| | | | <p>DEBURR AND BREAK SHARP EDGES/CONTOURS AT 0.2mm MAX</p> | | <p>SCALE: 1:3.5</p> | | <p>WEIGHT:</p> | | <p>COMMENTS:</p> |
| | | | <p>UNITS: mm [in]</p> | | <p>SCALE: 1:3.5</p> | | <p>WEIGHT:</p> | | <p>SHEET: 1 OF 1</p> |
| | | | | <p>DRAWN BY: AMY ZHU</p> | <p>DATE: 2023/11/29</p> | | | | |
| | | | | <p>APP. BY: SAM DING</p> | <p>DATE: 2023/11/29</p> | | | | |