

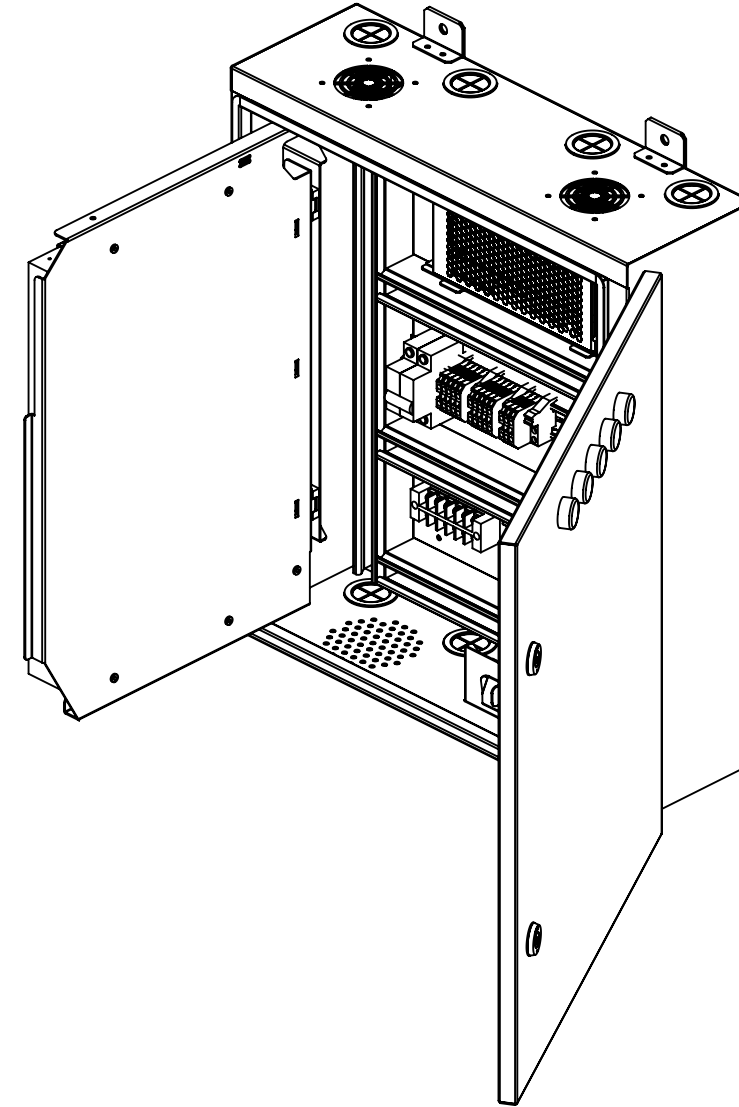

NOTES:

REVISIONS			
REV.	DESCRIPTION	DATE	APPROVED
A	FULL RELEASED	2024/2/1	CT

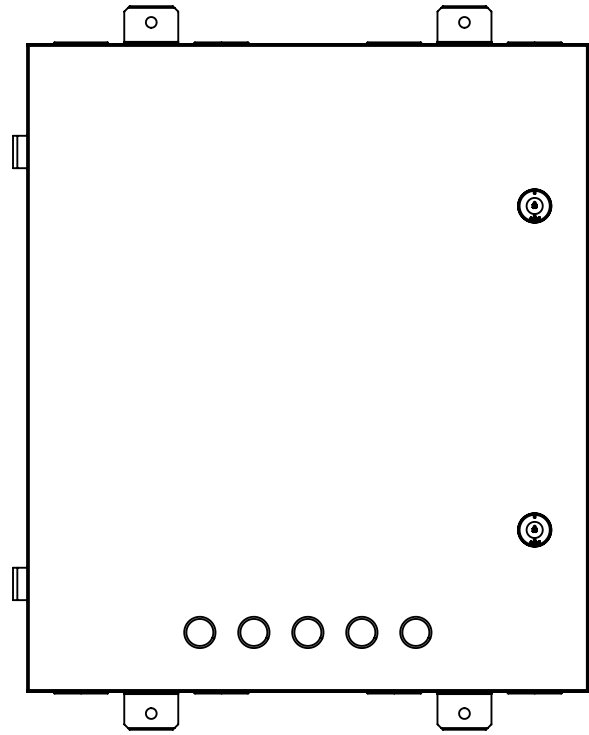

<p>PROPRIETARY AND CONFIDENTIAL</p> <p>THIS DRAWING AND ITS SPECIFICATIONS ARE THE PROPERTY OF INOVA AND SHALL NOT BE COPIED, REPRODUCED, OR USED IN WHOLE OR IN PART, AS THE BASIS FOR THE MANUFACTURE OR SALE OF ITEMS WITHOUT THE WRITTEN PERMISSION FROM INOVA. THIS DRAWING IS BASED UPON THE LATEST AVAILABLE INFORMATION AND IS SUBJECT TO CHANGE WITHOUT NOTICE.</p>	<p>UNLESS OTHERWISE SPECIFIED</p> <p>X = ± 1 X.X = ± 0.5 X.XX = ± 0.30 X.XXX = ± 0.130 ANGULAR X = 1° .X = 0.5° .XX = 0.25°</p>		<p>DESCRIPTION: POWER CONTROL BOX, FOR CONTAINMENT. 520MMX600MMX185MM.OUTPUT: <504W. WHITE .</p>	DRAWING NO: INV12-PB001		REV NO: A		
	 UNITS: mm [in]			<p>INTERPRET TO ASME Y14.100</p>	<p>MATERIAL: SEE INDIVIDUAL</p>	<p>FINISH: RAL 9003 TEXTURE</p>	<p>CLASS: N/A</p>	<p>SCALE: 1:7</p>
	<p>DEBURR AND BREAK SHARP EDGES/CONTOURS AT 0.2mm MAX</p>	<p>CLASS: N/A</p>	<p>SCALE: 1:7</p>	<p>WEIGHT:</p>	<p>SHEET: 1 OF 2</p>	<p>DRAWN BY: AMY ZHU 2024/2/1</p>	<p>APP. BY: SAM DING 2024/2/1</p>	

NOTES:

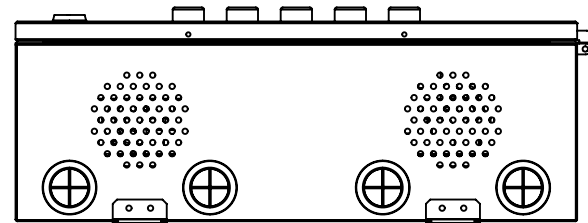
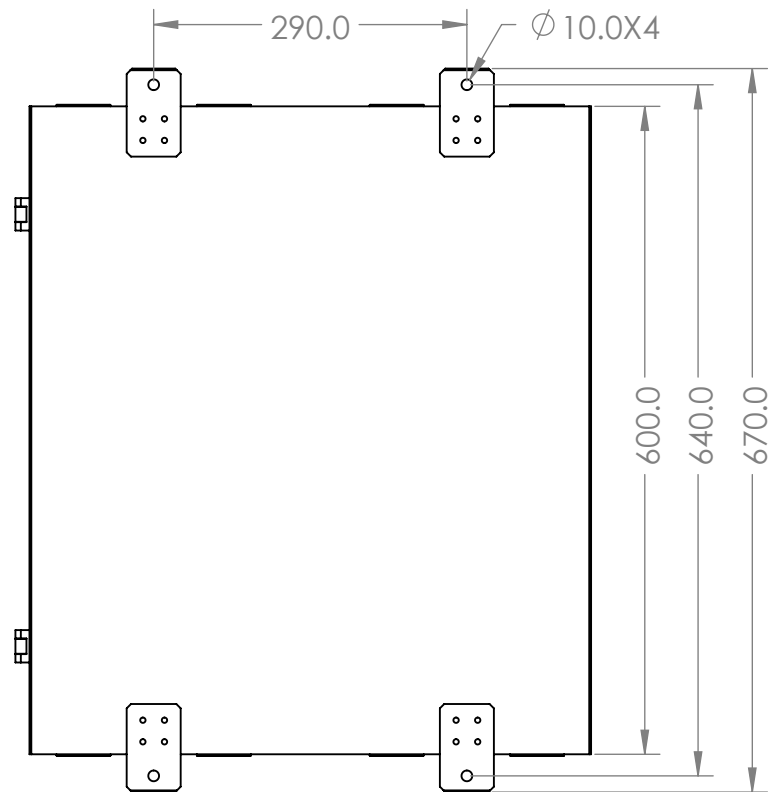
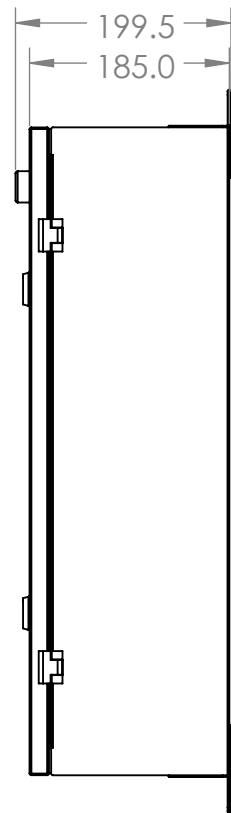
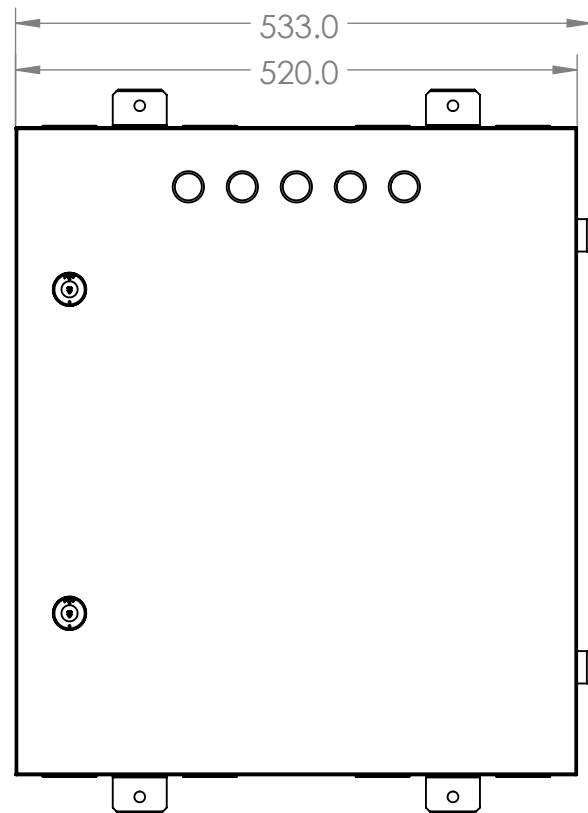
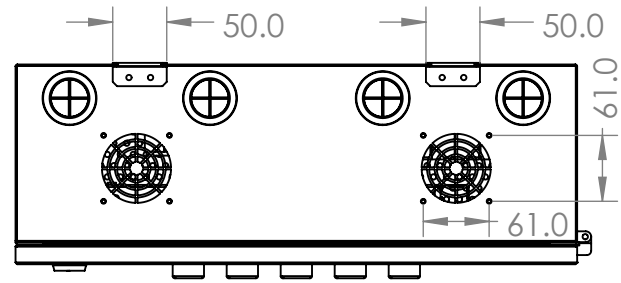

<p>PROPRIETARY AND CONFIDENTIAL</p> <p>THIS DRAWING AND ITS SPECIFICATIONS ARE THE PROPERTY OF INOVA AND SHALL NOT BE COPIED, REPRODUCED, OR USED IN WHOLE OR IN PART, AS THE BASIS FOR THE MANUFACTURE OR SALE OF ITEMS WITHOUT THE WRITTEN PERMISSION FROM INOVA. THIS DRAWING IS BASED UPON THE LATEST AVAILABLE INFORMATION AND IS SUBJECT TO CHANGE WITHOUT NOTICE.</p>	<p>UNLESS OTHERWISE SPECIFIED</p> <p>X = ± 1 X.X = ± 0.5 X.XX = ± 0.30 X.XXX = ± 0.130 ANGULAR X = 1° .X = 0.5° .XX = 0.25°</p>		<p>DESCRIPTION: POWER CONTROL BOX, FOR CONTAINMENT. 520MMX600MMX185MM.OUTPUT: <504W. WHITE .</p>	DRAWING NO:		REV NO:	
	<p>INTERPRET TO ASME Y14.100</p>			<p>INV12-PB001</p>		<p>A</p>	
	<p>DEBURR AND BREAK SHARP EDGES/CONTOURS AT 0.2mm MAX</p>	<p>CLASS: N/A</p>	<p>SCALE: 1:10</p>	<p>WEIGHT:</p>	<p>COMMENTS:</p>		<p>SIZE: B</p>
	<p>SEE INDIVIDUAL</p>	<p>FINISH: RAL 9003 TEXTURE</p>	<p>DRAWN BY: AMY ZHU</p>	<p>DATE: 2024/2/1</p>	<p>APP. BY: SAM DING</p>	<p>DATE: 2024/2/1</p>	<p>SHEET: 2 OF 2</p>